

# G.S.I AC Controller

---

Installation & User Guide

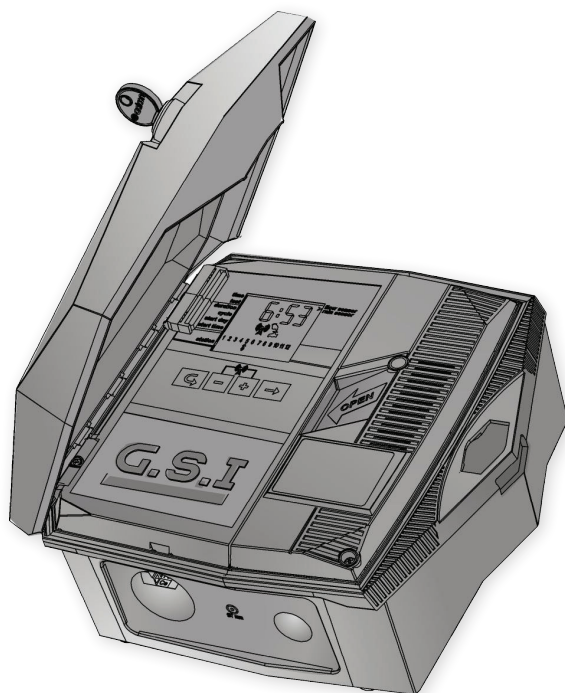



© 2012-2014 Galcon. All rights reserved.

Information in this documentation is subject to change without notice and does not represent a commitment on part of Galcon. The software described in this document is subject to the license agreement that is included with the product, which specifies the permitted and prohibited uses of the product.

Any unauthorized duplication or use of this documentation, in whole or in part, in print, or in any other storage or retrieval system is prohibited. No part of this publication may be reproduced, transmitted, transcribed, stored in a retrieval system, or translated into any language in any form by any means for any purpose other than the purchaser's personal use without the permission of Galcon.

## Contact Us

Galcon

Kfar Blum 1215000, Israel

Tel: 972-4-6900222

Fax: 972-4-6902727

E-mail: [info@galconc.com](mailto:info@galconc.com)

Visit us at: [www.galconc.com](http://www.galconc.com)

G.S.I web application: [www.gsi.galconc.com](http://www.gsi.galconc.com)

---

# Table of Contents

---

<b>1</b>	<b>Introduction .....</b>	<b>6</b>
	G.S.I Controller Models .....	6
<b>2</b>	<b>Setting Up the G.S.I Controller .....</b>	<b>7</b>
	Installing the Controller .....	7
	<i>Installing on a Wall or in a Control Cupboard .....</i>	<i>7</i>
	Establishing the Electrical Connections .....	9
	<i>Connecting the Solenoids to the Controller .....</i>	<i>10</i>
	<i>Connecting AC Power .....</i>	<i>12</i>
	<i>Connecting Backup Batteries.....</i>	<i>13</i>
	Connecting a Rain Sensor, a Flow Meter, and a Fertilizer Meter .....	14
	Inserting a SIM Card .....	15
<b>3</b>	<b>On-Site Controller Operation .....</b>	<b>17</b>
	Main Screen Features .....	17
	Verifying the Controller Signal Strength .....	19
	Establishing Communication with the Server .....	20
	Manually Setting the Controller Clock .....	21
	Testing Station Operation .....	21
	Creating an Irrigation Program.....	23
	<i>Setting Irrigation Program Durations .....</i>	<i>24</i>
	<i>Setting the Irrigation Cycle Time .....</i>	<i>25</i>
	<i>Setting the Irrigation Start Day and Time .....</i>	<i>27</i>
	Cancelling an Irrigation Program Start .....	29

Initiating Manual Irrigation for a Station .....	29
Resetting the Controller.....	30
Pausing and Resuming Irrigation from the Controller.....	31
System Alerts.....	32
<i>Fault Messages</i> .....	32
<i>Canceling Fault Alerts</i> .....	33
<i>General System Messages</i> .....	33
Locking and Unlocking the Screen.....	34
<b>4 Technical Specifications .....</b>	<b>35</b>

---

# List of Figures

---

Figure 1: Open Controller Cover.....	8
Figure 2: Control Panel Swung Outward .....	8
Figure 3: Opening the Internal Casing .....	9
Figure 4: Mounting Screw Holes on Back of Unit .....	9
Figure 5: Mounting Screw Holes Dimensions .....	9
Figure 6: Inserting the Mounting Screws with Cover Caps.....	9
Figure 7: Controller Terminal Blocks – New Model.....	11
Figure 8: Battery Compartment Removed .....	13
Figure 9: SIM Card Case.....	15
Figure 10: SIM Card Insertion Orientation .....	16
Figure 11: Correctly Inserted SIM Card .....	16
Figure 12: Main Screen.....	18
Figure 13: Signal Strength .....	20
Figure 14: Test Screen .....	22
Figure 15: Test Sequence Screen.....	22
Figure 16: Stop Test Sequence Screen .....	23
Figure 17: Fertilizer Test Screen .....	23
Figure 18: Duration Screen Example .....	24
Figure 19: Cycle Screen .....	25
Figure 20: Twelve Hour Cycle Setting Example .....	26
Figure 21: Six Day Cycle Setting Example .....	26
Figure 22: Start Day Screen Example.....	27
Figure 23: Start Time Screen .....	28
Figure 24: OFF Screen.....	28

Figure 25: OPEN Screen – immediate cycle start.....28  
Figure 26: Manual Irrigation Screen .....30

---

# 1 Introduction

---



The Galcon G.S.I Controller commands the irrigation valves in the field. It is connected wirelessly to the G.S.I web application that enables programming the controller remotely.

Creating irrigation programs for the G.S.I Controller is primarily done from the G.S.I Internet application. However, you can also create a simple irrigation program directly on the controller even before setting up the Internet application. You can also perform manual irrigation direct from the controller.

This manual describes how to install the G.S.I Controller, test to verify successful installation, perform basic, initial irrigation programming, and perform manual valve irrigation. For information on using the G.S.I web application, see the G.S.I web application online help available at: [www.gsi.galconc.com](http://www.gsi.galconc.com) enter with your user name and password and click the  Help icon.

## G.S.I Controller Models

There are two models of the G.S.I Controller, based on the type of power supply used:

-  DC unit, which supports either Alkaline or Lithium batteries.
-  AC unit.

This document describes the **G.S.I AC** unit.

---

## 2 Setting Up the G.S.I Controller

---

Setting up the G.S.I Controller system includes the following tasks:

- 🌞 Installing the Controller (see page 7)
- 🌞 Establishing the Electrical Connections (see page 9)

### Installing the Controller

The controller is designed to withstand outdoor installation conditions (at a rating of IP64). However it is preferable to provide additional protection from the climate by installing it in a sheltered position. Appropriate installation of the controller will ensure dependable operation throughout the years.

### Installing on a Wall or in a Control Cupboard

**To install the controller on a wall or in a control cupboard:**

1. Unlock and open the controller cover (Figure 1).
2. Swing out the control panel (Figure 2).
3. For the internal casing on the right side, unscrew the two screws and open the casing (Figure 3). Mount the controller to the wall or

## G.S.I AC Installation and Operation Guide

to the control cupboard through the marked holes (Figure 4 and Figure 5) with the aid of the three screws. Close the screws by hand only.

4. Close the internal casing and fasten its screws.
5. Swing the control panel back into place.
6. Close and lock the controller cover.

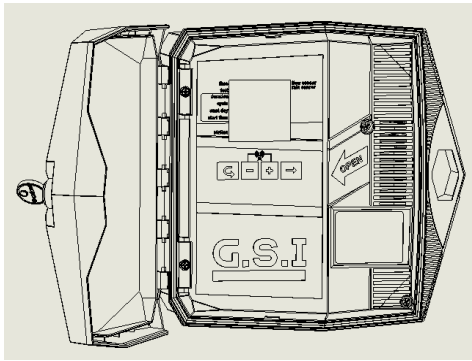

Figure 1: Open Controller Cover

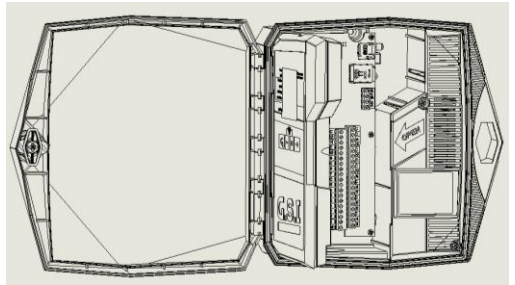
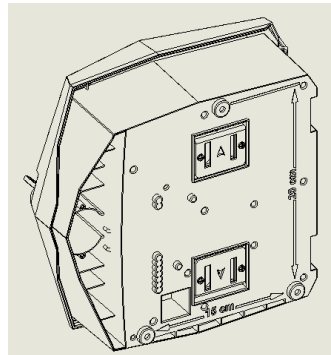
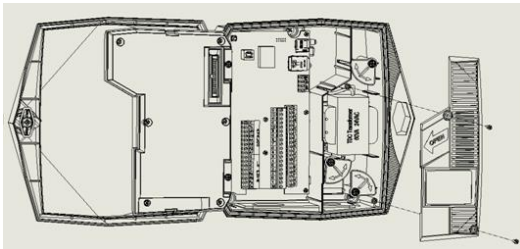

Figure 2: Control Panel Swung Outward



## G.S.I AC Installation and Operation Guide

Figure 3: Opening the Internal Casing

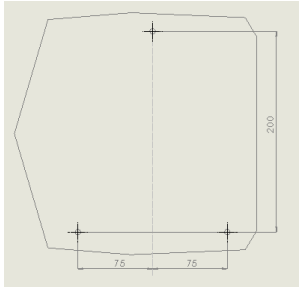

Figure 4: Mounting Screw Holes on Back of Unit

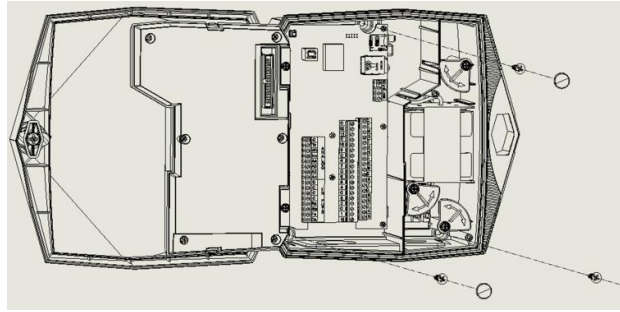

Figure 5: Mounting Screw Holes Dimensions

Figure 6: Inserting the Mounting Screws with Cover Caps

## Establishing the Electrical Connections

The AC G.S.I Controller has the following output connectors:

- ☀ Up to 24 irrigation valves
- ☀ Master valve

The G.S.I Controller has the following inputs:

- ☀ Rain sensor
- ☀ Water meter / Flow sensor
- ☀ Fertilizer meter

## Connecting the Solenoids to the Controller

### To connect the solenoids to the controller:

1. Insert the solenoid wires through the cable gland at the bottom of the controller and connect them.
2. Connect one wire coming from the solenoid to one of the outputs labeled with a number (1-24).
3. Connect the second wire to one of the common outputs, labeled **C**.
4. Connect the wires coming from the Master valve to the connector marked **M** and to common output marked **C**.
5. To connect a fertilizer, **always** connect the wires from the fertilizer to the connector marked **24** and to common output marked **C**.

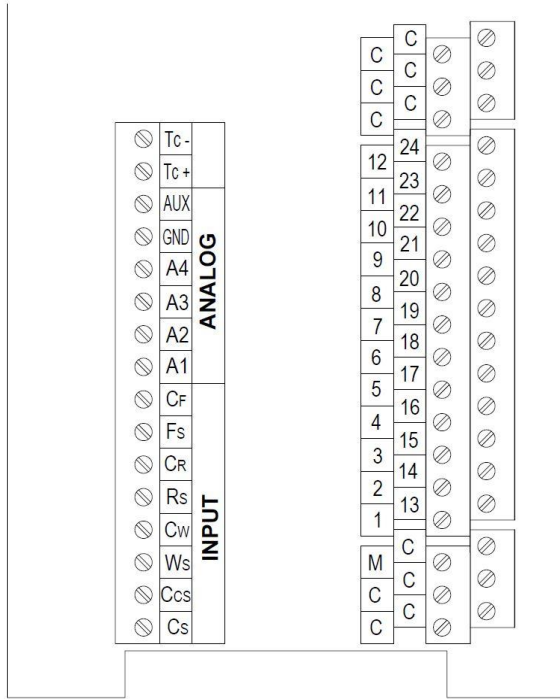

Figure 7: Controller Terminal Blocks – New Model

(older models may vary)



**Note:** It is highly recommended that you label the input wires, by function, for future reference.

## Connecting AC Power



**Warning!** Connecting to primary power source must be performed by a qualified electrical technician, following all local codes.

### To connect AC power:

1. Unlock and open the controller cover (Figure 1).
2. Swing out the control panel (Figure 2).
3. For the internal casing on the right side, unscrew the two screws and open the casing (Figure 3).
4. Route the AC power cable through the 1/2" pre drilled hole at the bottom of the controller. Always use 1/2" approved conduit male adaptor when installing the AC wiring.
5. Connect the wires to the feed through terminal block. The terminal block can be pulled out to be more easily accessed. Connect hot to the brown wire, neutral to the blue wire, and ground to the yellow wire.
6. Proceed to backup battery installation below.

## Connecting Backup Batteries

You must install backup batteries. In the event of a power failure, the batteries enable the modem to send power failure alerts.

### To connect a backup battery:

1. Turn the battery compartment latch by 90 degrees and pull out the battery compartment.

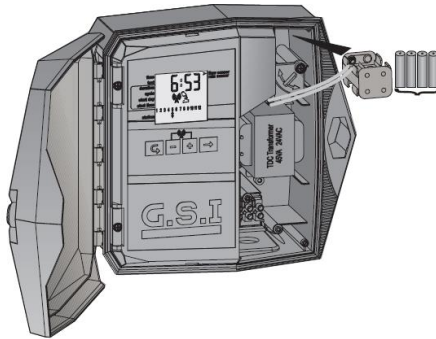



*Figure 8: Battery Compartment Removed*



2. Insert four AA 1.5 Volt batteries (not supplied), as a backup power source, into the battery compartment.
3. Return the battery compartment and lock it in place by turning the latch back until it clicks.
4. Close the internal casing and fasten its screws.
5. Swing the control panel back into place.
6. Close and lock the controller cover.

## Connecting a Rain Sensor, a Flow Meter, and a Fertilizer Meter

The GSI unit supports the following input devices:

-  Rain sensor
-  Water meter
-  Fertilizer meter

### To connect the input wires:

-  Rain sensor – Connect one of the rain sensor wires to the connector labeled **Rs**, and connect the second sensor wire to one of the connectors labeled **Cr**. The polarity of the wires is not important.
-  Flow meter – Connect one of the flow meter wires to the connector labeled **Ws**, and connect the second wire to one of the connectors labeled **Cw**. The polarity of the wires is not important.
-  Fertilizer meter - Connect one of the fertilizer meter wires to the connector labeled **Fs**, and connect the second wire to one of the connectors labeled **Cf** on the **INPUT** line.



**Note:** You must define the rain sensor, flow meter, and fertilizer meter in the G.S.I web application before you can use them.

## Inserting a SIM Card

The SIM card case is located on the upper left side of the controller board.



**Note:** Your SIM card definitions should already have been set by the manufacturer. If you are inserting an independent SIM card and you need to set its definitions, see the *SIM Card Definitions* guide provided by Galcon.

### To insert a SIM card:

1. Unlock and open the controller cover (Figure 1).
2. Swing out the control panel (Figure 2).
3. Locate the SIM card case.

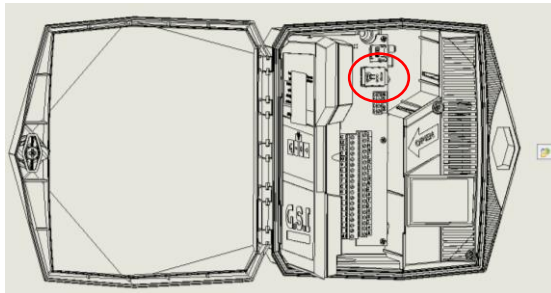

Figure 9: SIM Card Case

4. Slide the SIM card case cover to the side to open it, as indicated by the arrow labeled OPEN (see Figure 11).
5. Open the cover and slide the SIM card into the grooves located on

## G.S.I AC Installation and Operation Guide

the inner part of the case cover. Make sure that you have oriented the SIM card correctly.

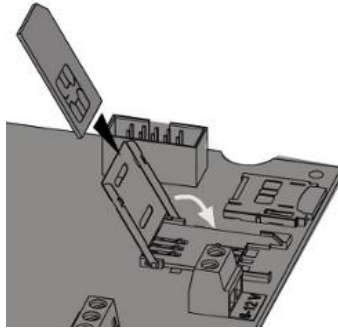

Figure 10: SIM Card Insertion Orientation

6. Close the case cover.
7. Hold the SIM card case cover down while you slide the cover to the side, as indicated by the arrow labeled LOCK (Figure 11).

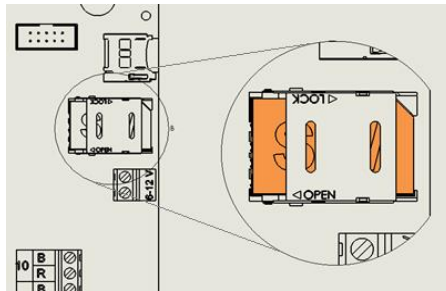

Figure 11: Correctly Inserted SIM Card

8. Swing the control panel back into place.
9. Close and lock the controller cover.

---

## 3 On-Site Controller Operation

---

The Galcon G.S.I Controller is designed to run irrigation programs created using the online G.S.I Internet application. In addition, however, the G.S.I Controller includes a control panel which enables basic, initial program creation.

The following sections outline how to set up the G.S.I Controller, create a basic irrigation program, and perform other irrigation and troubleshooting tasks.



**Note:** Programs defined from the G.S.I Controller control panel continue to operate until you explicitly deactivate them from the G.S.I Internet application, even if you upload a different program from the application.

### Main Screen Features

You can view information and monitor irrigation programs directly from the G.S.I Controller Main screen.

The following image displays the main screen icons and their meaning:

## G.S.I AC Installation and Operation Guide

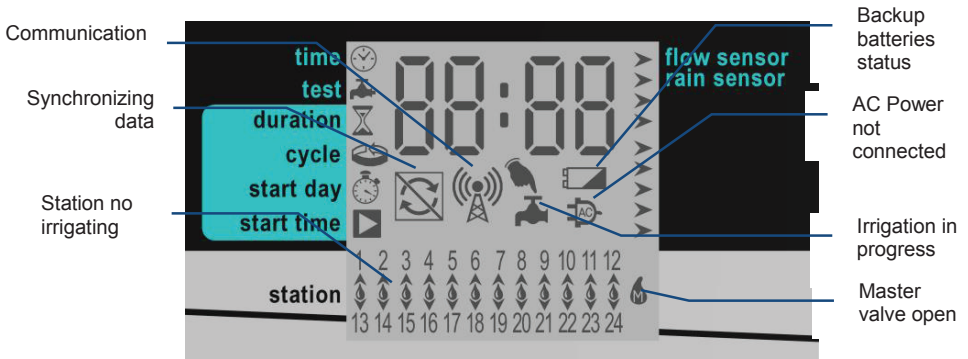

Figure 12: Main Screen

Press ➡ to cycle through the following information displays on the Main screen:

- 🌀 Current time (hh:mm format)
- 🌀 Flow value currently detected by the flow sensor (in m<sup>3</sup>/hr).



### Notes:

- Until the flow sensor is defined using the G.S.I Internet application, this screen does not display actual data.
- When there is no water flow, the flow value should be zero. If it is not, contact Galcon Support.

- 🌀 Current voltage of the controller's backup battery
- 🌀 Last four digits of the controller unit's 16-digit serial number
- 🌀 Current firmware version number

The Main screen is the launching point for all other G.S.I. controller operations. It displays the following information depending on the circumstances:

- ☀ By default – Displays the current time (hh:mm format).
- ☀ During irrigation – Displays a ♣ icon below the irrigation station in the list which is currently performing irrigation, as well as the amount of time remaining until that irrigation process finishes.

If more than one station is currently performing irrigation, the ♣ icon is displayed for each of them. In addition, a ▲ icon is displayed below one of those stations and the time displayed applies for that station.

Optionally press ➡ to cycle through the following information:

- ☀ Current program number
- ☀ Current water flow
- ☀ Current time
- ☀ Fertilizer meter

Press ➡ again to return to the main irrigation screen which displays the current irrigation program countdown.

In addition, on the left and right side of the screen, an icon indicates which screen you are currently viewing according to the list of screens printed on the unit.

## Verifying the Controller Signal Strength

After connecting AC power, the Main screen displays the letter r and a number ranging 1 to 99 representing the signal strength.





Figure 13: Signal Strength

## Establishing Communication with the Server

When setting up the G.S.I Controller for the first time, establishing communication with the server automatically sets the controller clock. Generally, communication is established automatically as soon as the G.S.I Controller is activated. However, in situations where this does not occur, you can manually establish communication with the server.

### To manually establish communication:

- Press **+** and **-** simultaneously. The  icon flashes on the screen while the unit synchronizes with the server. After the unit is synchronized, the  and  icons flash alternatively as long as the controller is in communication mode.

### To end communication manually:

- Press **+** and **-** simultaneously. Communication immediately ends. The controller display returns to the Main screen.

## Manually Setting the Controller Clock

In order for the controller to correctly operate the irrigation system at the desired times, the controller clock must first be set correctly. The controller clock is automatically updated every time the controller communicates with the server.

You can also manually set the time.

### To manually set the controller time:

1. Press and hold **+** until the minutes value in the displayed time start flashing. This indicates that the clock is in time-setting mode. Set the current time using the **+** and **-** buttons.
2. Press **↵** to exit time-setting mode, and press **↵** repeatedly until the Main screen is displayed. Verify that the time you set is correctly displayed.

## Testing Station Operation

The station operation test is intended to verify that all of the solenoids have been correctly installed. As you perform the test for each station, verify that water is flowing by checking the controller, the flow sensor, or even by visually inspecting the sprinklers to check that water is flowing from them.

### To test station operation:

1. Press **↵** until the Test screen is displayed (Figure 14).
2. Press and hold **+** until the Test Sequence screen is displayed (Figure 15). The controller automatically begins operating the

master station and each of the stations in sequence, for 60 seconds each. The currently operating station is marked with the  icon, and the screen displays the number of seconds remaining for that station's operation test.

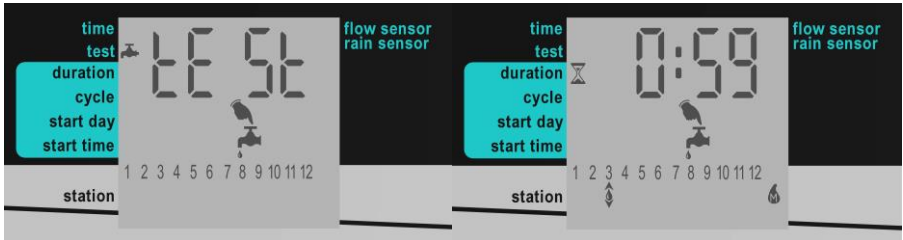

Figure 14: Test Screen

Figure 15: Test Sequence Screen

You can optionally extend or shorten a station operation test as follows:





-  To extend or to shorten the operation test time of the current station, press **+** or **-** respectively.
-  To close an operating station before its test time has elapsed and move to the next station, press **➡**. The  icon moves according to your selection.
-  To end the test sequence completely, press **+** and **➡** simultaneously. The screen displays **STOP** and the controller closes all the stations.



Figure 16: Stop Test Sequence Screen

**To test the fertilizer:**

Press mode  $\curvearrowright$  and – at the same time to open the fertilizer for 15 seconds.



Figure 17: Fertilizer Test Screen

**To test the Master valve:**

1. Press  $\curvearrowright$  until the Test screen is displayed (Figure 14).
2. Press – to open the Master valve for 30 seconds.

## Creating an Irrigation Program



**Notes:**

When locally creating the irrigation program:

- Stations always run in the order of their numbers.
- You can set a different duration for each station. The cycle time, start day, and start time apply for the first station in the sequence. As one station's irrigation duration ends, the next station automatically begins.
- Locally created irrigation programs continue operating even after you upload a detailed program from the G.S.I Internet

application – both programs will operate side by side. If you want to end the locally created program, you must cancel it in the G.S.I Internet application explicitly, or from the controller.

## Setting Irrigation Program Durations

Irrigation program duration, also known as the run time, can be defined for each station.

### To set the irrigation program duration:

1. Press **↶** until the Duration screen is displayed (Figure 18).
2. Press **➡** to move the **▲** cursor and select the station for which you want to define the irrigation duration.
3. Press **+** and **-** to set the irrigation duration for the selected station.

In Figure 18, the duration set is for 2 hours and 40 minutes for station 3. Duration of 0:00 sets the station to never open its valves (and therefore the sequence skips to the next station immediately).

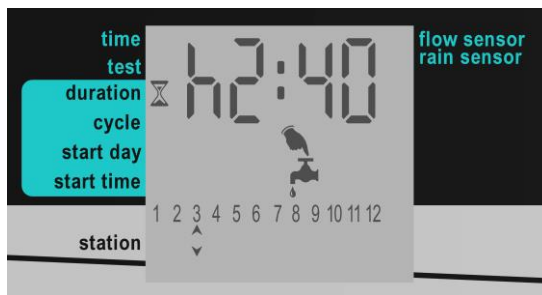

Figure 18: Duration Screen Example

## Setting the Irrigation Cycle Time

You can set an irrigation program to occur one time only, or to occur repeatedly according to a cycle.

When setting a recurring cycle, the cycle value you set defines the length of time (in hours or days) which passes between irrigations program start times.

### To set a one-time irrigation program:

1. Press **↵** until the Cycle screen appears (Figure 19). The message “OncE” is displayed by default, indicating that the cycle pattern is set to one time only.

If a cycle value other than “OncE” was previously set for the system, press **-** repeatedly until the message “OncE” appears.

2. Press **↵** to progress to the next screen, which automatically saves the change.



Figure 19: Cycle Screen

### To set cyclical irrigation programs:

1. Press **↵** until the Cycle screen appears (Figure 20).

## G.S.I AC Installation and Operation Guide

2. Press **+** once. The display changes from “OncE” to “h 00”, indicating zero hours.
3. Press **+** and **-** to increase and decrease the number of hours.



Figure 20: Twelve Hour Cycle Setting Example

If you increase past 24 hours, the display changes to “d 01”, indicating one day. You can continue to press **+** to increase the number of days up to 30 days.



Figure 21: Six Day Cycle Setting Example

4. After setting the desired cycle length, press **↶** to progress to the next screen, which automatically saves the change.

## Setting the Irrigation Start Day and Time

The start day is the number of days between the day you define an irrigation program (today) and the day the program actually begins operating. The start time is the time of day the program begins.

### To set the start day and time:

1. From the Main screen, press **↶** until the Start Day screen appears (Figure 22).



Figure 22: Start Day Screen Example

The default display is **d 00** which indicates zero days. If you set this value for the start day, the irrigation program will start on the current day at the defined start time. If that time has already passed for the current day, the program starts at that time the next day.

2. Press **+** and **-** to increase and decrease the number of days. In Figure 22, the value is set to 10 days. The maximum supported value is 30 days.
3. Press **↶** to save the defined start day and continue to define the start time in the Start Time screen. The default setting is **OFF**, which means that the irrigation program never starts.

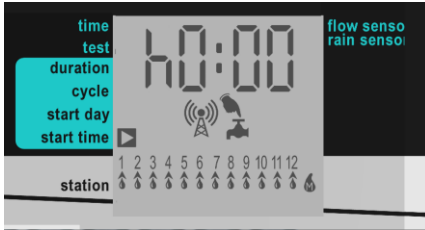

Figure 23: Start Time Screen

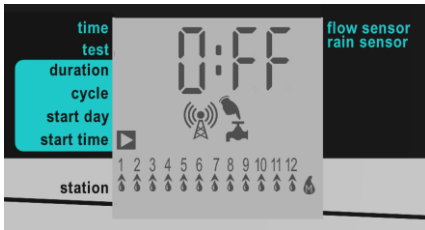

Figure 24: OFF Screen

4. Press **+** and **-** to set the start time. The possible range of values is 0:00 to 23:59. Alternatively, you can cycle through the time settings until reaching the **OPEN** option. Setting the start time to **OPEN** causes the irrigation cycle to start immediately after you save the start time setting (overriding the defined start day).

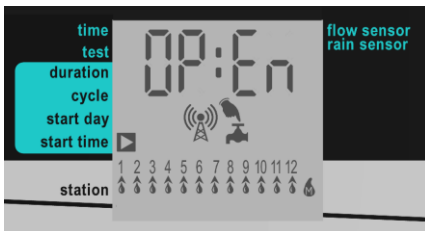

Figure 25: OPEN Screen – immediate cycle start

5. Press **↵** to progress to the next screen, which automatically saves the change.

## Cancelling an Irrigation Program Start

### To cancel an irrigation program start:

1. From the Main screen, press **↶** until the Start Time screen appears.
2. Press **−** until the start time is set to **OFF**. This defines that the irrigation program will never start.
3. Press **↶** to progress to the next screen, which automatically saves the change.

## Initiating Manual Irrigation for a Station

In addition to defining an irrigation program, you can manually initiate any station to begin irrigating. The irrigation is performed for the amount of time defined for that station's duration in the irrigation program you created using the controller's direct interface. This is true even if you have already uploaded a different program from the G.S.I Internet application. If no duration has been defined, the duration used is one minute.

### To initiate manual irrigation for a station:

1. From the Main screen, press **↶** until the Start Time screen appears.
2. Press **➡** to select a station.
3. Press **+**. The station immediately starts irrigating for the length of its defined duration.



Figure 26: Manual Irrigation Screen

4. Optionally, press **+** or **-** to increase or decrease the duration of the current irrigation.

## Resetting the Controller

If a technical problem occurs, you may want to reset your G.S.I Controller.

### To reset the controller:

1. Press the **Reset** button, located in the top-left corner of the G.S.I Controller's circuit board. The reset process clears the controller's RAM, and performs the following sequence of operations:
  - a. All the screen icons appear simultaneously on the screen and gradually disappear after a few minutes.
  - b. The screen displays the controller's serial number followed by the current firmware version on the controller.
  - c. The screen displays the numbers of the valves connected to the controller. The controller starts closing the valves one by one; as each valve is closed, its number disappears from the screen and the CL OS message is displayed. Optionally press **➡** to abort this process and skip to the next operation.

- d. The controller establishes communication with the server; the  icon flashes on the screen as long as the controller is in communication mode.
- e. The controller ends communication and resumes normal operation.



**Note:** Resetting the controller does not delete or cancel the locally created irrigation program.

## Pausing and Resuming Irrigation from the Controller

The controller enables you to pause irrigation. While a pause is in effect, all irrigation programs currently in progress are paused, and any new irrigation programs which were scheduled to start are not started.

While irrigation is paused in this way, you can still perform station operation tests and establish communication with the server.

When the pause is ended and irrigation is resumed, all irrigation programs continue according to the following rules:

- While paused, programs are delayed until midnight. As such, if the pause is ended before midnight the programs resume where they left off, and scheduled programs for that period will run.
- If the system pause condition ended after midnight, all delayed programs are canceled and will initiate irrigation according to their next scheduled timing.

**To pause an irrigation program:**

- Press **–** continuously until the message “PA US” is displayed on the screen. This indicates that the irrigation is now paused. The “PA US” message flashes on the screen until you resume irrigation.

**To resume irrigation:**

- Press **–** continuously until the Main screen is displayed.



**Note:** the controller will react according to the paused rules also in the following occasions:

- AC power off
- Rain sensor activation

## System Alerts

The G.S.I Controller features various kinds of system alerts, including fault messages and other problem indicators.

### Fault Messages

If a fault occurs in the system, the controller screen displays the message “FLt” or “FL” and a fault number.

*Fault Numbers and Definitions*

Fault Indication Message	Description
FLt 0	Low flow.

Fault Indication Message	Description
Flt 1	High flow.
Flt 2	No water flow.
Flt 3	Unexpected flow start.
Flt 4	No fertilizer flow.
Flt 5	Unexpected fertilizer flow- unit suspended!
Flt 7	Low battery voltage.
Flt 8	Empty batteries.
FL 11	Short circuit.
FL 13	Controller memory.

## Canceling Fault Alerts

**To cancel an alert and remove the fault message from the screen:**

With the fault message displayed, press – and ➡ simultaneously.

## General System Messages

- 🌀 Flashing low battery icon – When the backup battery is low, a flashing battery icon appears on the display. This indicates that the backup battery should be replaced.
- 🌀 AC Off – If for any reason the controller stops receiving AC power

from the main line, a blinking AC icon is displayed. While this is the case, the controller can still be programmed and manual communication will still be possible, as long as backup battery power is available. However, valves cannot be opened and programs cannot be performed according to the schedule.

- Valve short circuit – In the event of a short circuit in a valve, or one of its connections, a ● icon flashes on the display over the relevant valve number, and the word **Shrt** is displayed for few seconds. The flashing ● icon remains on the screen until the valve is restored to successful operation. The next time the valve is scheduled to be opened, the controller tries opening the valve again.

## Locking and Unlocking the Screen

The G.S.I Controller enables you to lock the screen, preventing people from editing the unit's programming until the screen is unlocked.

### To lock the screen:

- Press **↵**, **+** and **➡** at the same time. The screen is locked and displays “= = =”.

### To unlock the screen:

- Press **↵**, **+** and **➡** at the same time. The screen is unlocked and the unit can be programmed.

---

## 4 Technical Specifications

---

- ☀ Transformer input: 230V 50 Hz, or 110V 60 Hz for American models
- ☀ Transformer output: 24VAC 2.5 amp
- ☀ Outputs:
  - ☀ 24 field valves, 1 fertilizer (**out of** the 24 valves), 1 master
  - ☀ Station output: 0.5 amps per station
  - ☀ Simultaneous irrigation: 4 valves + 1 Master (up to 1.5 amps)
- ☀ Inputs:
  - ☀ Rain switch Normally Open or Normally Close
  - ☀ Pulse water meter
  - ☀ Pulse fertilizer meter
- ☀ Electronic short circuit protection
- ☀ Non-volatile memory for program data
- ☀ Backup Batteries: 4X1.5V AA type Batteries.
- ☀ Cellular modem: Quad band GSM modem integrated (GPRS class 10) for operating in all GSM operators globally.
- ☀ Dimensions: 10.5x24.5x25.5 CM
- ☀ Operating ambient temperature: -10°C to 60°C, 14°F to 140°F.

## LIMITED WARRANTY CERTIFICATE AND TERMS OF SERVICE FOR "GSI"

1. Galcon sells the "GSI" irrigation controller ("the product") and provide associated product software ("the Product Software") and certain services ("the Services") through Galcon's Web Site (gsi.galconc.com) ("the Site"). This Limited Warranty Certificate and Terms of service ("these Terms") constitute a legal agreement between Galcon and the original purchaser of the Product ("the Customer"), and shall govern the Customer's access and use of the Services and the Product. By accessing the Site and/or by using the Services and/or the Product, the Customer agrees that he has read, understood, accept and agree to be bound by these Terms. If the Customer does not agree with any of the provisions of these Terms, the Customer must not access or use the Services and/or the Product.
2. Galcon's Warranty for the Product and/or the Services only extends to the Customer who, upon requesting warranty service, must present Galcon with a valid and dully signed contract with Galcon (or any of its authorized dealers) together with a valid purchase receipt. Failure to produce the said documentation will result in the request for warranty being null and void.
3. Galcon warrants to the Customer that the Product shall materially conform to the description in Galcon's documentation and shall be free from defects in material and workmanship. Accordingly, Customer's sole and exclusive remedy under this warranty is the repair or – to Galcon's sole discretion – the replacement of the Product or any parts according to the terms of this Warranty, and no other remedy shall be available. Therefore, if - within the Warranty Period - the Product is proven to be defective by reason of faulty workmanship or materials by Galcon, Galcon undertakes, with reasonable promptness, to have the defective Product (or any part/s thereof) repaired, or at Galcon's discretion, replaced; All subject to the terms and conditions of these Terms.
4. Galcon's warranty for the Product and/or the Services and/or otherwise, shall not apply to any of the following: (i) any conduct (by act or omission) not by Galcon, including any misuse/abuse of any Product and/or the Services (or part/s thereof), and/or any failure to install and/or use any Product in full compliance with Galcon's instructions; (ii) other systems/components/devices/technologies and/or the integration/interface thereof with any Product; (iii) any part/component which has been included/installed in any Product not at Galcon's approval and/or other than by Galcon; (iv) any actual or attempted change/repair/interference of with any Product (including any use/handling of, and/or interference/dealing with, any code of any software included/used in the Product) other than by Galcon; (v) any data/information/content which has been inserted/included in a Product and/or the Services; (vi) malfunction or damage resulting from accidents, which occur during transit and/or handling, and/or malfunction or damage due to fire, earthquake, flood, lightning and/or any other external disaster; (vii) unforeseen accidents, wear and tear, or any other external factors beyond Galcon's reasonable control, or to any Product installed, repaired, adjusted, rebuilt, modified, changed or converted by any person (including the Customer) other than Galcon;
5. In addition and without derogating from the provisions of these Terms, Galcon's warranty and the Customer's rights to use/access the Services and/or the Site, is conditioned upon the all of following Customer's undertakings taking place: (i) Customer's operating and maintaining the Product and/or the Services in accordance with Galcon's instructions; (ii) Customer's not being in default of any payment obligation to the Galcon (or its authorized dealer, as relevant); (iii) the Customer shall not license, sell, rent, lease, transfer, assign, distribute, host, or otherwise commercially exploit the Services; (iv) the Customer shall not to modify, make derivative works of, disassemble, reverse compile, or reverse engineer any part of the Services; (v) the Customer shall not to access the Services and/or the Site in order to build a similar or competitive service; (vi) except as expressly stated herein, no part of the Services may be copied, reproduced, distributed, republished, downloaded, displayed, posted, or transmitted in any form or by any means; (vii) the Customer shall not upload, transmit, or distribute any computer viruses, worms, or any software intended to damage or alter a computer or communication network, computer, handheld mobile device, data, the Services, the Product, the Product Software, or any other system, device or property; (viii) the Customer shall not interfere with, disrupt, or attempt to gain unauthorized access to, the Site, the servers or networks connected to the Services or violate the regulations, policies, or procedures of such networks; (ix) the Customer shall not access (or attempt to access) any of the Services by means other than through the interface that is provided by Galcon; (x) the Customer shall not remove, obscure or alter any proprietary rights notices (including copyrights and trademark notices) which may be contained in or displayed in connection with the Services; (xi) any use or access by anyone under the age of 18 is prohibited.
6. Subject to these Terms, as well as additional guidelines, terms, or rules referred to in this document and incorporated by reference into these Terms, Galcon grants the Customer a non-transferable, non-exclusive, limited right (without the right to sublicense) to use the Services for the Warranty Period only and solely for the purpose of controlling and monitoring the Product installed on Customer's property.
7. Galcon does not give any warranty or guarantee whatsoever in respect of any Product or Services (or any part/s thereof) which has not been manufactured and distributed by Galcon and which has not been purchased from Galcon or any of its authorized dealers, whether such products are branded with any trademarks similar to any trademark belonging to or used by Galcon.
8. After replacement or repair of the Product, the Warranty for the new or repaired Product shall be valid only for the non-expired period of the original Warranty Period. Any defective Products or part/s, which has been replaced, shall become Galcon's property.
9. Galcon reserves the right to charge the Customer if any warranty service is requested and carried out but no fault is found in the Product or if such defect/fault is not under Galcon's Warranty.
10. Notwithstanding anything to the contrary, Galcon shall not be responsible and/or liable, under any circumstances and in any way, for any loss, damage, costs, expenses, expenditures, responsibility and/or liability (including of Customer and/or any third party) – including (without limitation) direct and/or indirect (including incidental and/or special and/or consequential), however arising, including in respect of damages to or loss of property and/or equipment, loss of profit, loss of use, loss of revenue or damages to business or reputation, whether or not based on breach of contract, tort (including negligence), product liability or otherwise - arising from the performance or non-performance of any aspect of the Services and/or the Product and/or access to Site or any part thereof; All of the above, whether or not Galcon and/or the Customer shall have been made aware of the possibility of such loss.
11. In any event, any liability which Galcon may have in connection with the Product and/or the Services and/or access to Site and/or these Terms, including (without limitation) in connection with and/or resulting from the Product (or any part thereof) and the use thereof and/or the Services, shall be limited to a total amount (for all damages, claims and causes of action in the aggregate) equal to the consideration actually received by Galcon from the Customer for the Product. The limitations shall apply whether the liability is based on contract, tort, strict liability or any other theory.

12. The Customer warrants and agrees, that Galcon owns and shall continue to own all title, rights and other interests (including all intellectual property rights) in connection with the Product, the Site, the Services, and all content available through the Site, including any and all trademarks, service marks, and logos contained therein. The provision of the Product, the Product Software, and/or the Services does not transfer to the Customer or any third party any rights, title, or interest in or to such intellectual property rights. The Customer may not copy, further develop, reproduce, republish, modify, alter, download, post, broadcast, transmit, or otherwise any material made available in the Site or the Services.
13. The customer creates data when he uses the service that is related to programming the product. The customer hereby provides Galcon with a license to use, upload, display, copy, manipulate, and store any data that the Customer shall create/insert when he uses the Services and/or the Product. The customer acknowledges and agrees that he shall always remain solely responsible and liable for its said data.
14. Galcon has no obligation to accept, display, review or maintain any Customer content. Moreover, Galcon reserves the right to edit, delete, distort or move Customer's content from the Site and/or Services without notice for any reason at any time. Any submitted Customer's content shall not be considered confidential and may be disseminated by Galcon without any compensation to the Customer. Customer's content may be available to the public, and the Customer should have no expectation of privacy with respect to its content. The Customer acknowledge that he provide his personal information at its own risk.
15. The Customer warrants and agrees, that the Provision of Services is dependent upon the receipt of information from a variety of third party sources, including with respect to weather data and therefore cannot guarantee the accuracy of such information. The site and services are provided on an AS IS and on available basis without warranties of any kind from Galcon. The use of the Site, the Product and/or the Services is at the Customer sole risk.
16. Galcon is not responsible for any problems or technical malfunction of any telephone network or lines, wireless network of any kind (Wifi, Cellular, Bluetooth or other) computer online systems, servers or providers, computer equipment, or software due to technical problems or traffic congestion on the internet or on the Services and/or the Site. Under no circumstances shall Galcon be responsible for any loss or damage resulting from use of the Product, Site and/or the Services.
17. Galcon may suspend or terminate the Services and/or the Customer's account at any time upon written notice to the Customer that the Customer breaches these Terms and, to the extent that the breach can be cured, the Customer does not cure that breach within 14 (fourteen) days.
18. This Warranty and the remedies set forth herein are exclusive and in lieu of all other warranties, remedies and conditions, whether oral, written, statutory, express or implied. Galcon specifically disclaims any and all statutory or implied warranties, including, without limitation, warranties of merchantability and fitness for a particular purpose and warranties against hidden or latent defects.
19. The Customer shall be solely responsible for the selection, use, efficiency and suitability of the Product(s).
20. The provisions of this Limited Warranty Certificate shall be interpreted and governed, solely and exclusively, pursuant to the laws of the State of Israel, and no other law shall apply. Any and all legal actions shall be litigated within the jurisdiction of the courts of Israel, and no other jurisdiction shall apply.



Residential  
Gardening



Turf &  
Landscape



Greenhouse



Open  
Fields

Email: [info@galconc.com](mailto:info@galconc.com), Website: [www.galconc.com](http://www.galconc.com)